

F4 Series

Zone 0 blowers

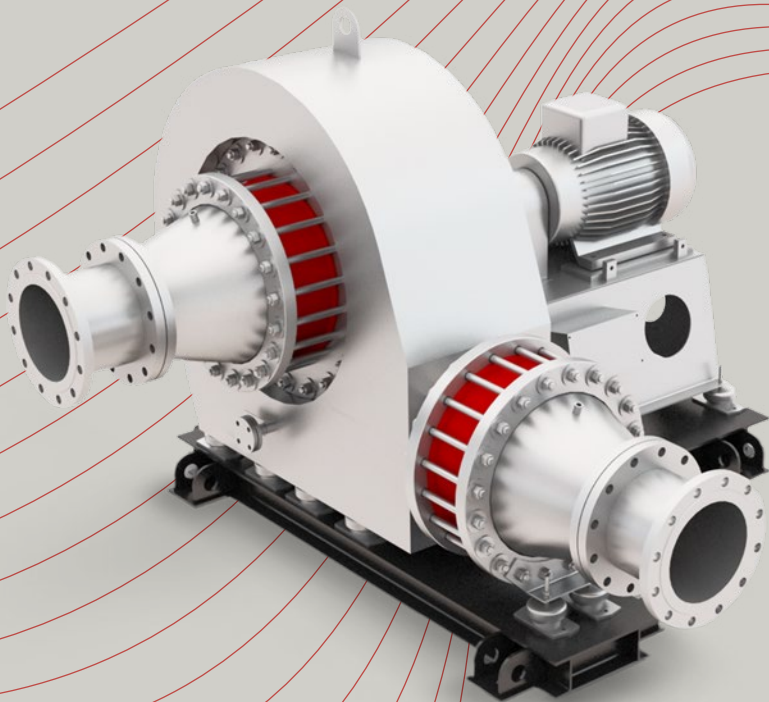

FIMA – world market leader for explosion-proof Zone 0 blowers

FIMA is world market leader in the Zone 0 blower sector. These blowers are designed to move permanently explosive gases.

By handling Zone 0 rated gases your plant is constantly exposed to the risk of explosion. This is why safety in relation to the constant risk of gas explosion is one of the key aspects of our blower. Our equipment provides maximum protection for your employees and your plants.

Our machines are able to handle the explosion groups IIA, IIB and IIB3. In terms of temperature classes we are able to cover classes T1-T6. Our fans are put to use in tank terminals, chemical mixers, paint booths and many other applications.

Full certification and conformity with the latest environmental constraints enable eco-friendly operation and facilitate permission by local authorities.

Potential ignition hazards

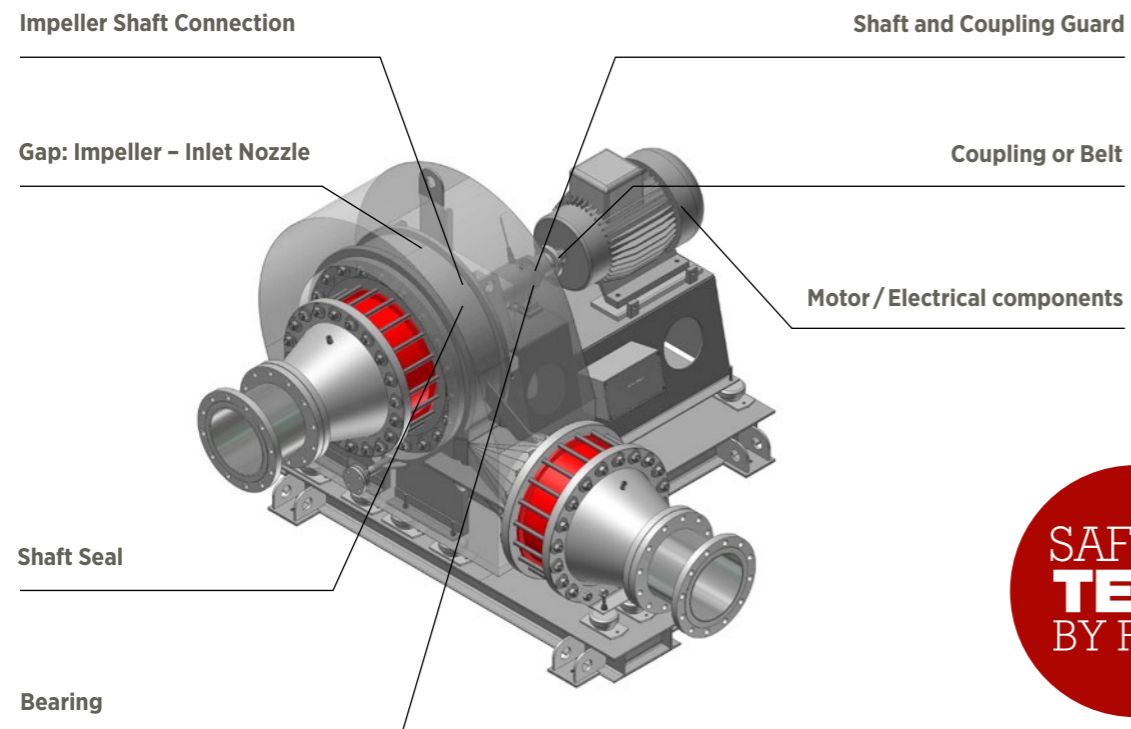

Our know-how for your safety

FIMA standard types and their ranges

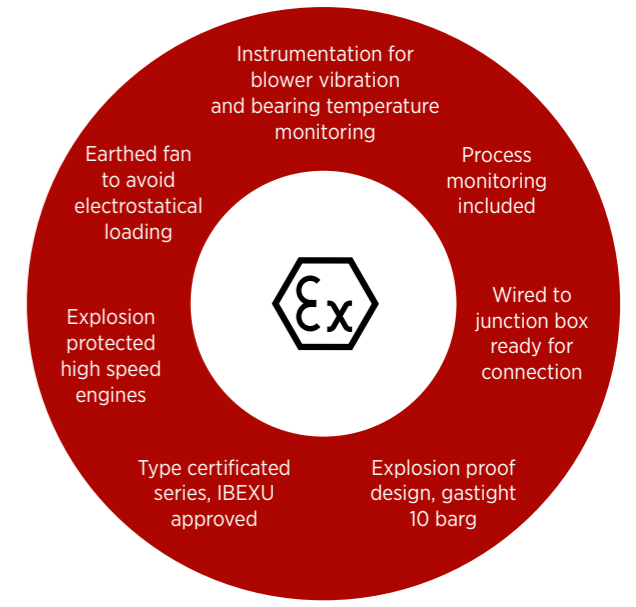
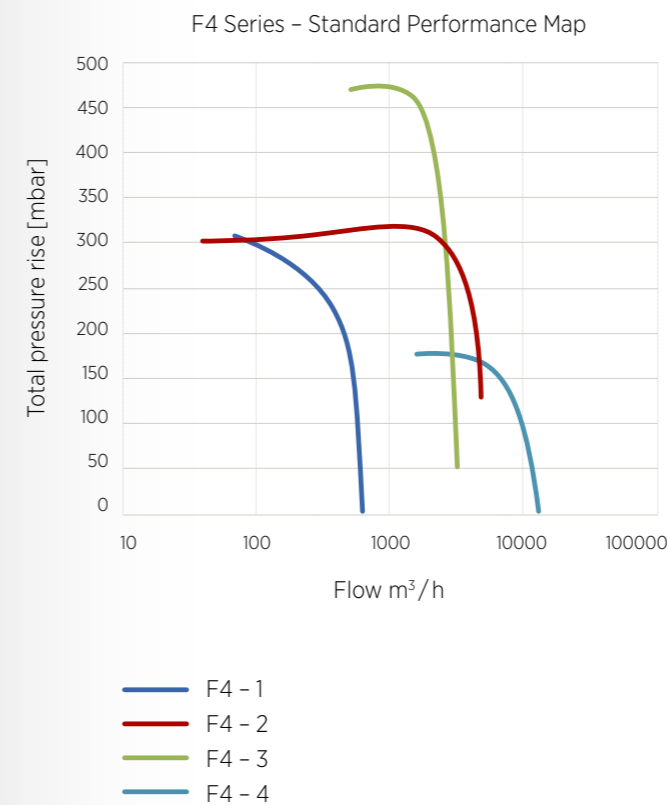

Technical data

Volume flow	up to 12000 m ³ /h
Inlet temperature	Up to 60 °C
Inlet pressure	800 to 1200 mbar
Pressure rise	up to 450 mbar
Motor output	up to 120kW

Machine drives

Direct drive blower

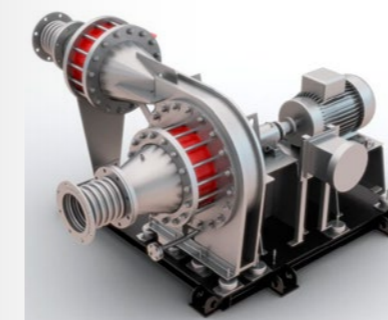

Coupling blower

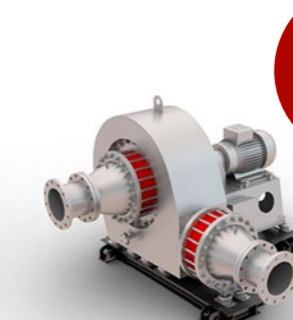

Belt drive blower

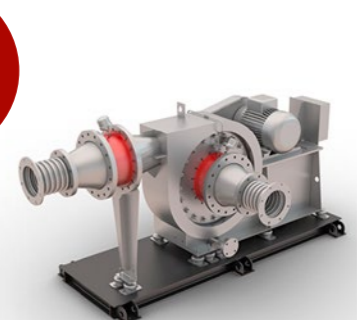

FIMA here. How can we help you?

FIMA Maschinenbau GmbH

Oberfischacher Straße 58
74423 Obersontheim
Germany

Tel.: +49 7973 693-0

Fax: +49 7973 767

info@fima.de

Service hotline:

+49 171 7968741

service@fima.de